

Vitalograph[®]

ALPHA

MODEL 6000

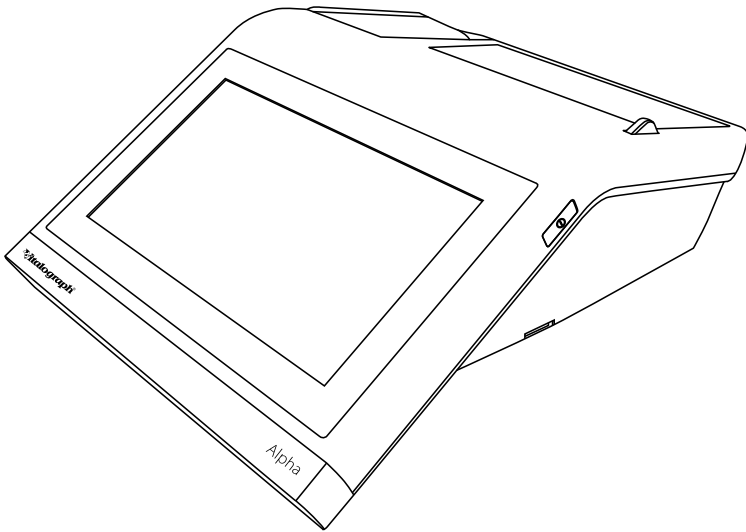

Rx Only

Instructions for Use

Vitalograph Branch Addresses

Vitalograph Ltd, UK

Maids Moreton, Buckingham
MK18 1SW
England

Tel: 01280 827110

Fax: 01280 823302

E-mail: sales@vitalograph.co.uk

www.vitalograph.com

Technical Support

Tel: 01280 827177

Email: technical.support@vitalograph.co.uk

Vitalograph Ltd, International

Maids Moreton, Buckingham
MK18 1SW
England

Tel: +44 1280 827120

Fax: +44 1280 823302

E-mail: sales@vitalograph.co.uk

www.vitalograph.com

Technical Support

Tel: +353 65 6864111

Email: technical.support@vitalograph.ie

Vitalograph GmbH

Rellinger Straße 64a
D-20257 Hamburg
Germany

Tel: +49 40 547391-0

Fax: +49 40 547391-40

E-mail: info@vitalograph.de

www.vitalograph.com

Technical Support

Telefon: +49 40 547391-14

E-mail: technical.support@vitalograph.de

Vitalograph Inc.

13310 West 99th Street
Lenexa, Kansas, 66215
USA

Toll Free: 800 255 6626

Tel: (913) 730 3200

Fax: (913) 730 3232

E-mail: contact@vitalograph.com

www.vitalograph.com

Technical Support

Tel: (913) 730-3205

Email: technical.support@vitalograph.com

Vitalograph (Ireland) Ltd

Gort Road Business Park
Ennis, Co Clare, V95 HFT4
Ireland

Tel: +353 65 6864100

Fax: +353 65 6829289

E-mail: sales@vitalograph.ie

www.vitalograph.com

Technical Support

Tel: +353 65 6864111

Email: technical.support@vitalograph.ie

© Copyright Vitalograph 2023
Current Edition (Issue 6, 29-Nov-2023)
Cat. No. 09060

 is a registered trademark.

Contents

1. Indications for Use	4
2. Contraindications, Warnings, Precautions and Adverse Reactions	4
3. Main Components	6
3.1. Features	7
4. Setting up the device	7
5. Operating Instructions.....	8
5.1. Entering Subject Data.....	10
5.2. Conducting a Test.....	11
5.3. Reporting.....	17
5.4. Calibration Verification.....	19
5.5. Connection to Electronic Medical Records (EMR) via Vitalograph Connect	20
5.6. Passcode	24
5.7. Incentives	24
5.8. Data Transfer with Spirotrac	25
6. Cybersecurity Considerations.....	26
6.1. Specification	26
6.2. Security Recommendations.....	27
6.3. Interfaces	27
7. Power Management.....	27
7.1. Battery Pack.....	27
7.2. Battery Power Indications	28
7.3. Power Save Mode.....	28
8. Cleaning & Hygiene	28
8.1. Preventing Cross-Contamination of Subjects.....	28
8.2. Inspection of the Vitalograph Model 6000 Alpha.....	29
9. Fault Finding Guide.....	31
9.1. Software Check.....	32
9.2. Product Useful Life Checks.....	32
10. Customer Service	33
11. Consumables and Accessories	33
12. Disposal	34
13. Explanation of Symbols	34
14. Description of the Vitalograph Model 6000 Alpha	35
15. Technical Specification	36
16. CE Notice	38
17. FDA Notice.....	41
18. EU Declaration of Conformity	42
19. Guarantee & Free Five Year Warranty.....	43

1. Indications for Use

The intended use of the Vitalograph Model 6000 Alpha is in the simple assessment of respiratory function through the measurement of dynamic lung volumes i.e. spirometry. The device measures patient respiratory parameters including FVC, FEV₁, FEV₆, PEF, MVV and VC. The device is designed to be operated by medical professionals trained in respiratory and lung function testing on adults and paediatrics, 5 years and older, in a variety of professional healthcare environments, e.g. primary care, hospitals and occupational healthcentres.

2. Contraindications, Warnings, Precautions and Adverse Reactions

1. No modification of this equipment is allowed. Any unauthorised changes to the device may compromise product safety and/or data and as such Vitalograph cannot be held responsible and the device will no longer be supported.
2. The device is not designed as a sterile device. Always follow the safety guidelines given by the manufacturer of cleaning and disinfectant chemicals.
3. Vitalograph intends that a new Bacterial Viral Filter (BVF™) be used for every subject to prevent cross contamination. Using a new BVF provides a significant level of protection of the subject, the device and the user against cross contamination during spirometry manoeuvres. A BVF is for single use only.
4. Spirometry may support or exclude diagnosis, but it cannot make one (ATS/ERS 2019¹).
5. The Alpha is marked as 'Rx Only' and as such is restricted to sale by, or on the order of a physician.
6. When using the device ensure that the flowhead connecting tube is not pinched or trapped as spirometry results may be affected, or a false reading may be detected.
7. Take care not to block the flowhead with tongue or teeth during testing. A 'spitting' action or cough will give false readings.
8. Subject fatigue may occur during spirometry testing depending on the subject's characteristics e.g. age, health status. For safety reasons, testing should be preferably done in the sitting position, using a chair with arms and without wheels. Subject may also take a break between tests. A max test completed message will appear after eight manoeuvres.
9. All values displayed are expressed as BTPS values.
10. Time zero is determined using the back-extrapolated method, from the steepest part of the curve.
11. Do not expose the device to liquids.

¹ ATS/ERS Standardisation of Spirometry Eur Respir J 2019

12. The device should not be used in the presence of flammable liquids or gases, dust, sand or any other chemical substances.
13. All spirometry standards recommend completing a calibration verification of lung function measuring devices daily with a 3-L syringe to verify that the instrument is measuring accurately. The device should never be outside accuracy limits. A calibration verification should also be completed after cleaning or disassembling the spirometer for any reason, after adjusting calibration or if the flowhead or device has been dropped.
14. Service and repairs should be carried out only by the manufacturer or by Service Agents approved by Vitalograph.
15. Maintenance must not be performed while the device is in use by a subject.
16. The device contains a Lithium coin cell battery and a NiMH main battery which are not accessible by the user. Any suspected battery faults should be reported to the manufacturer.
17. The internal NiMH battery is not user accessible or user replaceable. In the unlikely event that any issues are noted with the power or battery such as swelling or leaking, stop using the device immediately, do not charge the device and contact Vitalograph support. In case of leaking ensure the electrolyte does not get in the eyes or touch skin. If electrolyte gets into the eyes flush the area immediately with water for 15 minutes and seek medical attention. If it gets on the skin wash the affected area immediately and seek medical attention. Do not inhale the leaked material, leave the area immediately and allow the battery to cool and any material to dissipate.
18. To isolate the device from the mains supply, remove the 12V Power Supply from the mains wall socket. When charging the device via the 12V Power Supply do not position the Power Supply where it is difficult to unplug from the socket.
19. The paper tear bar has sharp edges to allow the printouts to be removed cleanly. Once the printer door is closed the paper tear bar is covered. Users should take care with their fingers when replacing the paper roll. When disassembled for cleaning the flowhead and base have exposed edges. Once assembled the edges are covered. The user should take care with their fingers when assembling or disassembling the flowhead.
20. The internal (thermal) printout will fade over time when exposed to light or heat. If a permanent record is required, photocopy the thermal printout or send the report to the Device Studio Utility.
21. Use of accessories and cables other than those specified or provided by Vitalograph for this equipment could result in increased electromagnetic emissions or decreased electromagnetic immunity of the device and result in improper operation.
22. Non-medical equipment must be kept outside the subject environment i.e. any area in which intentional or unintentional contact between the subject and parts of the system, or some other persons touching part of the

system, can occur.

23. Portable RF communications equipment (including peripherals such as antenna cables and external antennas) should be used no closer than 30 cm (12 inches) to any part of the device, including cables specified by Vitalograph. Otherwise, degradation of the performance of this equipment could result.
24. Use of this equipment adjacent to or stacked with other equipment should be avoided because it could result in improper operation. If such use is necessary, this equipment and the other equipment should be observed to verify that they are operating normally.
25. Avoid exposure to known sources of EMI (electromagnetic interference) such as diathermy, lithotripsy, electrocautery, RFID (Radio Frequency Identification), and electromagnetic security systems such as anti- theft/ electronic article surveillance systems, metal detectors. Note that the presence of RFID devices may not be obvious. Loss or degraded performance due to EMI that exceeds the test levels in immunity test tables below will result in a failed calibration verification. Reference section 5.4 of this document for details on completing a calibration verification on the Alpha. If interference is suspected or possible, move the Alpha to a new location and repeat the calibration verification

3. Main Components

The main components are:

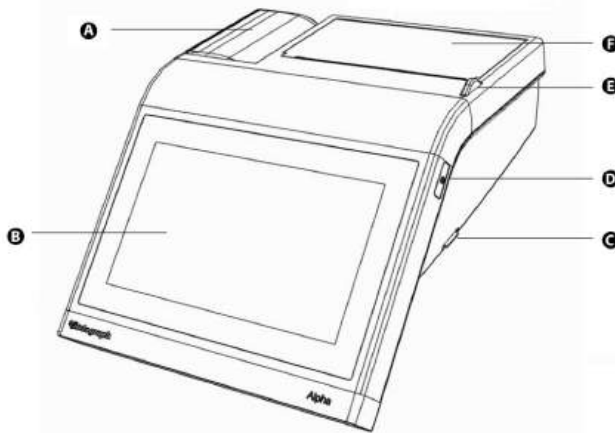

Figure 1.a

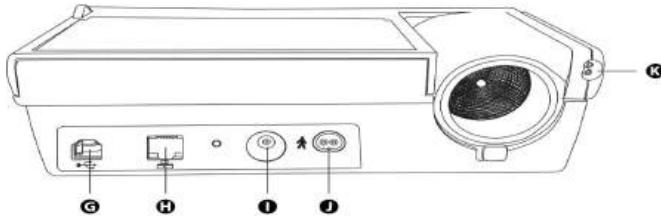

Figure 1.b

A	Flowhead
B	Touchscreen display
C	Micro SD card connector
D	On/Off button
E	Printer door release button
F	Printer
G	USB connector
H	Ethernet connector
I	Power supply input
J	Flowhead tubing connector (device)
K	Flowhead tubing connector (flowhead)

3.1. Features

The features include:

- Fleisch type pneumotachograph
- Ambient temperature sensor
- Colour touchscreen display
- Sounds for audio feedback
- Integral 4" thermal printer

4. Setting up the device

Check that the contents of the packaging match the contents label inside the carton.

Preparing for use:

1. Unwrap flowhead connection tubing and connect one end to the device base. The tubing is keyed, so will only connect one way.
2. Connect the other end of flowhead tubing to the flowhead.
3. Open the printer door and check that a roll of thermal paper is present.

4. Only use the device with the purpose-built low voltage power supply unit with which it is supplied. Attempted use with other power sources may cause irreparable damage and invalidate the warranty. The output from the power supply is 12 volts DC.
5. Connect the power supply into the socket on the rear of the device. Plug the mains plug into a suitable socket, press the On/Off switch on the side of the instrument. The device is ready for use.
6. The device is fitted with rechargeable batteries, which allows the device to be used without the power supply connected.
7. On first use the internal battery pack will require a full charge, this may be completed overnight and will take a minimum of 12 hours.

If the device has just been unpacked or transported, ensure that it is left sitting, fully powered and is at room temperature prior to testing.
 Ensure a calibration verification is completed at least once daily, prior to using the device (see Section 5.4 Calibration Verification).

5. Operating Instructions

On all screens:

the (blue) arrow  at the top left goes back one step,

the (green) arrow  at the top right moves forward one step.

1. After turning on the device for the first time, the Start-up Wizard opens giving 2 options:

Device Config allows the user to change audio level, haptic feedback, screen brightness, enable/disable passcode, units and language.

Date/Time allows the user to update the Date/Time.

2. If defaults are acceptable, press the green arrow  to move to the main menu.
3. The Main Menu offers three standard options - Subject, Quick Test and Configuration - and a fourth option Connect, if Connect is configured.

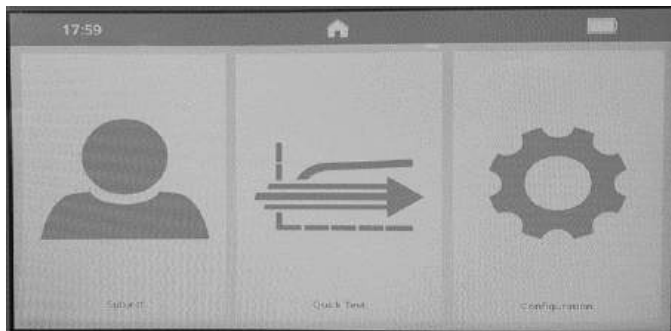

Figure 2.a

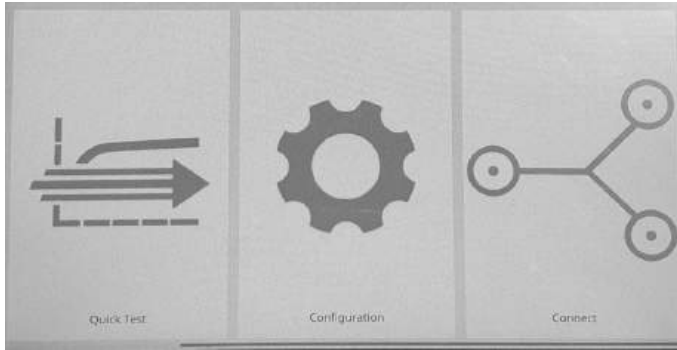









Figure 2.b

The Calibration Verification prompt  displays in the centre of the screen when the device has just been powered on if a calibration verification has not been completed that day. To complete a calibration verification, press the green  button (see Section 5.4 Calibration Verification).

If a calibration verification is not required press .

4. Subject allows the user to select a current subject  by ID, forename or surname (see Section 5.2 Conducting a Test) or to add/create a new subject  (see Section 5.1 Entering Subject Data). All subject demographics may be added in the add subject screen.
5. Quick Test allows the user to select Spirometry  or Reports . Reports will always be blank for the Quick Test.

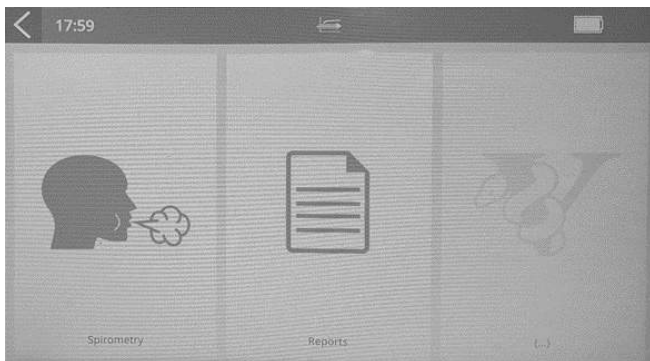











Figure 3

Spirometry option includes VC, FVC and Post (see Section 5.2 Conducting a Test).

Report option allows printing of a subject's report to the internal printer (see Section 5.3 Reporting).

6. Configuration - allows the user to:

- carry out a calibration verification  (Section 5.4),
- configure reports  (Section 5.3),
- configure parameters for test  (Section 5.2),
- configure the device  including audio level, haptic feedback and screen brightness level, enable/disable passcode (Section 5.6), choose metric and language.
- setting the date and time , population groups  (Section 5.1),

Connect configuration  (Section 5.5), Incentives configuration 
 (Section 5.7) and has the About box  containing details of the device, including software revision number (Section 9.1).

5.1. Entering Subject Data

1. Select 'Subject' from the Main Menu.





2. Select 'Add Subject'

Subject information fields are divided into primary and secondary, on 2 separate pages. Enter details in subject information fields:

Primary: ID , Date of Birth , Height , Birth Sex ,

Population .

Secondary: Alternative ID , Forename , Surname 

Weight , Smoker and Pack years .

On the comments page, comments may be freeform or selected from a pre-defined list.





3. Press the green forward arrow to save subject details and return to main menu. A warning will appear on screen that no predicted values

will be generated if a required field is missed.

5.2. Conducting a Test

1. Before starting a test session ensure that a calibration verification of the device was completed recently (refer to Section 5.4 Calibration Verification).
2. Select a subject  and ensure subject details are entered.
3. Wash hands (operator and subject).
4. Fit a disposable BVF to the flowhead. The use of a disposable nose clip is recommended.
5. Instruct and demonstrate the test.

5.2.1. Testing

1. Select 'VC Test'  or 'FVC Test'  from 'Spirometry' in the Main Menu.
2. Select how the results should be presented by scrolling across the screens or pressing the circles  at the top of the screen:
 - VC Test - Volume/Time (V/T) graph or Volume (Bar Chart).
 - FVC Test - Volume/Time (V/T) graph or Flow/Volume (F/V) graph.
3. When the 'Exhale to Begin' icon appears  the device is ready to accept a blow.
 - Sit upright, fit the nose clip and relax.
 - Place BVF in mouth and close lips around the mouthpiece.
 - Seal lips around the mouthpiece and keep the tongue down.
 - Breathe normally.

VC test session

- a. Breathe normally until the end-expiratory lung volume is stable. Stability is defined as having at least three tidal breaths with end expiratory lung volume within 15% of the tidal volume (the device will alert a user when this has been achieved).
- b. Inhale completely, with a brief pause when lungs are completely full (≤ 2 secs).
- c. While maintaining an upright posture, exhale in a relaxed manner with no hesitation until no more air can be expelled.
- d. It is vital that the operator encourages the subject to keep exhaling to ensure all air is expelled (when a plateau has been reached or expiration time reaches 15 seconds).
- e. The operator should repeat instructions as necessary, with

enthusiasm.

- f. When prompted by the device that a satisfactory expiratory flow plateau has been achieved or expiration time >15 seconds, inhale maximally and then return to normal breathing.
- g. The manoeuvre is now complete. Remove the BVF from the mouth.
- h. Listen for two beeps. The device is now ready for the next blow.
- i. Repeat for a minimum of three manoeuvres, up to a maximum of eight.
- j. Check VC repeatability and perform more manoeuvres as necessary.
- k. Click on  for quality information and test acceptability. Acceptability may be changed from 'Auto' to 'Accepted' or 'Rejected'. Click again to exit.

Note: A single-breath VC technique may also be performed on the device.

FVC test session:

- a. Inhale completely and rapidly, with a brief pause when lungs are completely full (≤ 2 secs).
- b. While maintaining an upright posture, exhale with maximal effort until no more air can be expelled.
- c. It is vital that the operator encourages the subject to keep exhaling to ensure all air is expelled (when a plateau has been reached or forced expiratory time (FET) reaches 15 seconds).
- d. The operator should repeat instructions as necessary, with enthusiasm.
- e. Breathe in with maximal effort until completely full. The manoeuvre is now complete, remove the BVF from the mouth.
- f. Listen for two beeps. The device is now ready for the next blow.
- g. Repeat for a minimum of three manoeuvres, up to a maximum of eight.
- h. Check FEV₁ and FVC repeatability and perform more manoeuvres as necessary.
- i. Click on  for quality information and test acceptability. Acceptability may be changed from 'Auto' to 'Accepted' or 'Rejected'. Click again to exit.

Note: A single-breath FVC technique may also be performed on the device.

Results grading for FEV₁ and FVC is shown below in Table 1.

Grade	Number of measurements	Repeatability: Age >6yr	Repeatability: Age ≥5yr and ≤6yr
A	≥ 3 acceptable	Within 0.150L	Within 0.100 L*
B	2 acceptable	Within 0.150 L	Within 0.100 L*
C	≥ 2 acceptable	Within 0.200 L	Within 0.150 L*
D	≥ 2 acceptable	Within 0.250 L	Within 0.200 L*
E	≥ 2 acceptable OR 1 acceptable	> 0.250 L N/A	> 0.200 L* N/A
U	0 acceptable AND ≥ 1 usable	N/A	N/A
F	0 acceptable and 0 usable	N/A	N/A

*Or 10% of the highest value, whichever is greater; applies for age ≥5yr and ≤6yr

Table 1: Grades

5.2.2. Post Testing

Post testing can be performed on any pre-test session performed.

1. Select 'Spirometry' from the Menu, then select 'Post' .
2. Select the relevant pre-test from the list and perform the post-test as outlined in Section 5.2.1 Testing.

Note: A Post-test may only be completed if an existing Pre-test is available.

5.2.3. Viewing FVC Test Results

- Results may be viewed as either a Volume/time (V/t) or Flow/Volume (F/V) graph by scrolling across the screens or pressing the circles  at the top of the screen. Screens viewed in order: F/V graph, V/t graph, Results screen.
- The Results screen first tab displays Best, %Pred, Pred values, the second tab displays Bestz-score, LLN and the third and subsequent tabs display the individual tests (up to a maximum of 8)





- To change the Acceptability, select the individual test # from the results tab. Acceptability may be changed from 'Auto' to 'Accepted' or 'Rejected'. Click on  for quality information.
- There are additional options to add comments and information on

session quality and session interpretation.

The user may add comments of up to 250 characters to the results

by clicking  in the top right corner. Select again to save and close.

The icons  and  in the bottom right corner allow the user to select from pre-defined comments as per ATS/ERS 2019. Select again to save and close.

The icon  in the top right corner displays the session information, quality, and interpretation. Select again to close.

5.2.4. Viewing VC Test results

VC test results may be viewed as either a Volume/time (V/t) or Volume Bar graph by scrolling across the screens. First screen is the bar graph, second is the V/t graph, third is the Results screen. All other viewing is as per Section 5.2.3

5.2.5. Saving and ending the Test Session

The device has capacity to store at least 20,000 tests, with a maximum of 8 blows allowed for each test session. Stored session information includes subject details and best pre-test if it is a bronchodilator responsiveness test session.

A session ends and is saved when the user exits the test screen by

pressing the green arrow  on the top right.

A session also ends and is saved if any of the following occur:

- The device is turned off.
- A new subject is created.
- The device is connected to Device Studio.

5.2.6. GOLD ATS/ERS Interpretation

Gold 2019: Global strategy for the diagnosis management and prevention of COPD.

Base FVC Interpretations algorithm.

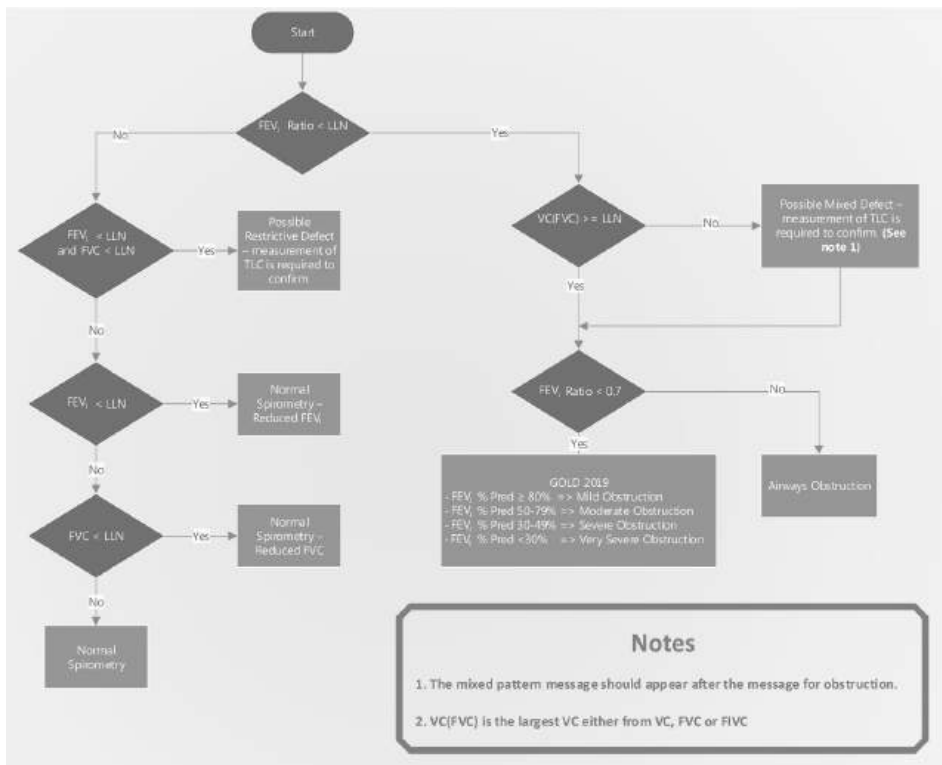

Notes

1. The mixed pattern message should appear after the message for obstruction.
2. VC(FVC) is the largest VC either from VC, FVC or FIVC

Post FVC interpretation algorithm.

EN

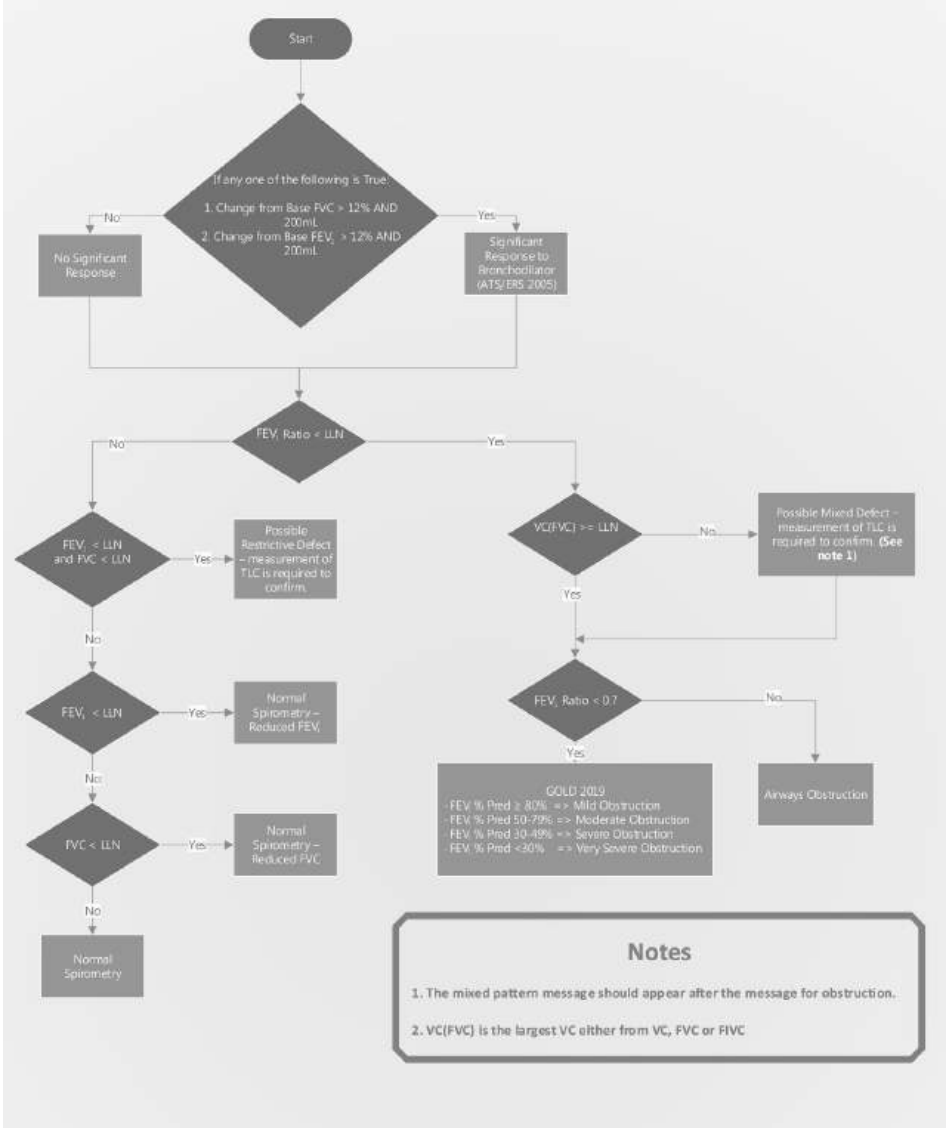



Notes

1. The mixed pattern message should appear after the message for obstruction.
2. VC(FVC) is the largest VC either from VC, FVC or FIVC

5.3. Reporting

To print the current subject test session:

1. Select the green forward arrow to go to the print screen.
2. Select the 'Print' icon  on screen.
3. Alternatively returning to the main menu and selecting the 'Reports' option will display a list of the sessions available for print. Clicking on a session will allow it to be reviewed, a long press will print.
4. To stop the print, press the red  button that is displayed on screen
5. Report Configuration: Select  in 'Configuration' of the Main Menu to configure reports. Options include enable/disable predicted shading, predicted I-bars, test graphs, report % predicted, session comments, subject comments, environmental data, auto acceptability and posture.

5.3.1. Internal Printer

The device has an internal 4" thermal printer.

To load paper to the internal printer: with the device facing forward press the printer button to open the door. Remove the tape from the new paper roll, unroll a small amount of paper and load it into the paper holder with the blue writing facing out on the right-hand side. Close the printer door.

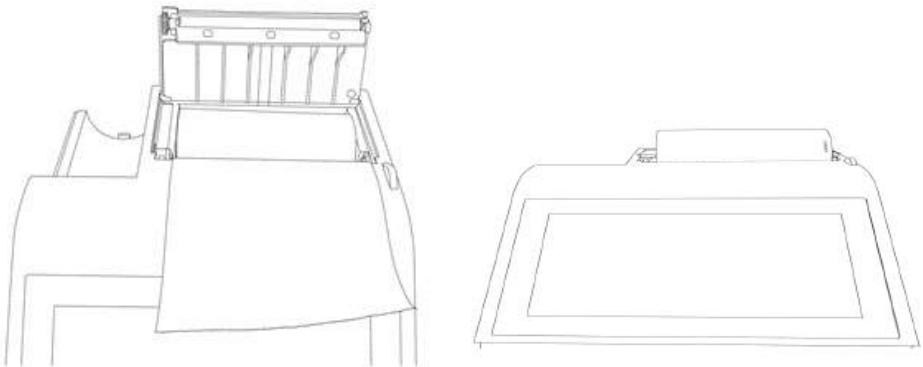

Figure 4

Note: The internal (thermal) printout will fade over time when exposed to light or heat. If a permanent record is required, photocopy the thermal printout or send the report to the Device Studio Utility.

5.3.2. External Printer via Vitalograph Device Studio

The device can print to an external printer using the Device Studio

application.

To generate PDF reports from the device:

1. Use the USB cable supplied to connect the device to a computer running Device Studio.
2. Ensure that Device Studio application is open, the device is switched on and in the main screen. If the device is not already connected, click on the 'Connect Device' option in the menu.

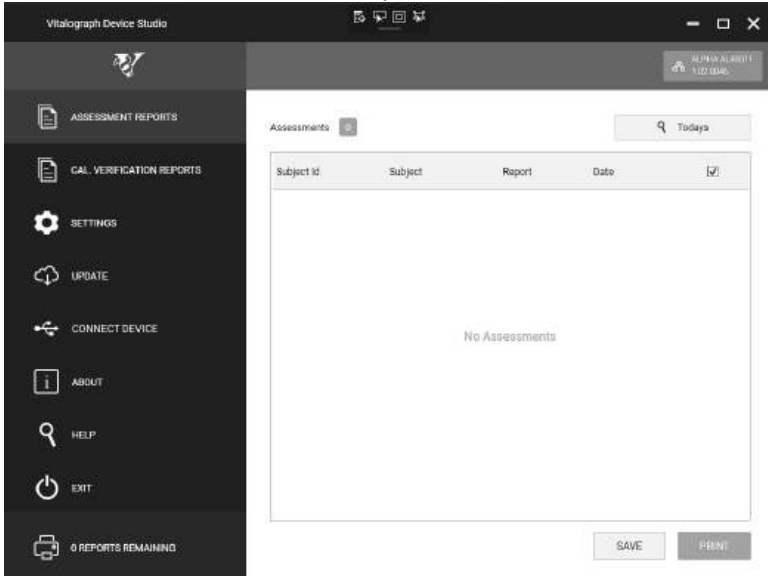

Figure 5.a

3. Device Studio will search for assessments on the device (see Fig 5.a). Available assessments are shown on screen and may be selected and printed and/or saved (see Fig 5.b).



Figure 5.b

4. Device Studio may also be used to print/save calibration verification reports and to update device firmware.

5. When finished with Device Studio click on the 'Disconnect Device' option in the application menu before disconnecting the USB cable/device.

Note: *If the USB cable/device is disconnected prior to clicking the 'Disconnect Device' option the device will restart.*

Additional guidance on using Device Studio can be found in the Instruction for Use PN 09550 supplied on the USB flash drive PN 93002 and in the software help menu of the application.

The settings option allows the user to configure information displayed on the session report.

5.4. Calibration Verification

ISO 26782 recommendations require that the difference between the volume measured by the spirometer and the volume pumped into the spirometer from a syringe is within 3% (2.5% for the device with an additional 0.5% allowed for the syringe).



1. Attach the flowhead to the syringe as per figure 6.



Figure 6

2. Select 'Configuration' on the main menu, select 'Calibration Verification'  option.
3. Enter syringe details: serial number, syringe volume (will default to 3L), pressure, altitude and humidity %. At a minimum the serial number, syringe volume and temperature must be entered. The temperature auto fills from the internal temperature sensor but may be changed if required. If a calibration verification was performed previously this will pre-populate with the details of last syringe used.
4. Press Continue and follow the on-screen instructions.
5. For each stroke, press in and immediately withdraw the syringe with a smooth, firm stroke (not too slowly), maintaining a consistent flow rate to verify both expiratory and inspiratory.
6. Three repeatable syringe strokes within 3% of the syringe volume are required, it is recommended to use varying flow rates.
7. If the reproducibility between the 3 consecutive syringe strokes is less than 3%, the calibration verification has passed, and a green tick displays on the syringe icon and <3% is displayed in the in the top of the results table.

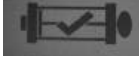
In the unlikely event the result is outside 3% or non-reproducible, an error icon will display.

	Successful verification check with tick in syringe indicating a pass.
	Non-reproducible syringe strokes (red syringe, after the 5 th Stroke). Repeat calibration verification.
	<p>Outside 3%, 6% or 25% (purple syringe, and shows >3%, >6% or >25% in top right corner of screen). The % it is out by indicates the severity of the issue. Over 3%, repeat calibration verification. Over 6% may indicate the device requires cleaning or maintenance. Over 25%, the user should contact technical support.</p>

The following displays after the calibration update:

	Calibration update (purple syringe with purple tick in a circle, % shown in top right corner of screen).
---	--

A report may be printed or saved for the calibration verification if required, see Section 5.3 Reporting.

If the procedure was followed correctly and the error icon is showing, the calibration verification may be repeated. If the error continues to show, contact the manufacturer using contact information at the start of this document.

Note: A calibration verification is recommended daily, after the device is stored or transported, the flowhead is dropped or replaced and if EMI (Electromagnetic Interference) is suspected or possible.

5.5. Connection to Electronic Medical Records (EMR) via Vitalograph Connect

Connection to an EMR system may be achieved using the Connect service. This is available on the Flash Drive PN 93002 supplied with the device. Refer to the Connect IFU PN 09570 for information on installing and running Connect.

5.5.1. Connect Configuration

On the main menu select 'Connect Config' .

The following information is required:

- Address: URL for the Connect service - `http://{host}[:{port}]/`

connect

- Network information: Three options - disabled, wired or wireless.

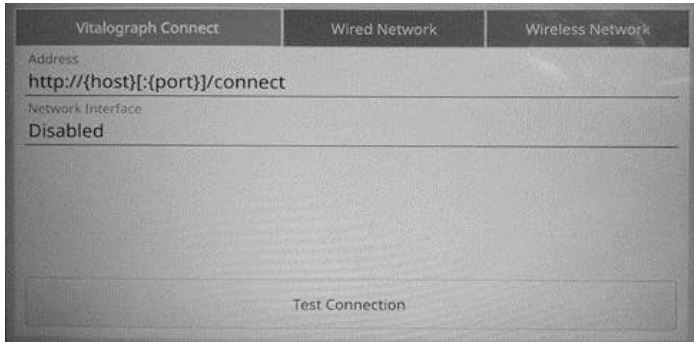
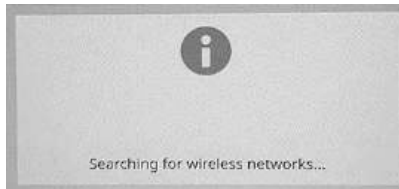

Figure 7 – Example set up for Connect

Once the information is entered, select the appropriate tab: wireless or wired.

a. Wireless Network

1. When the wireless tab is selected the device searches all available networks.



2. Select the required network and enter passkey. The 'Advanced' option allows the user to add/edit the advanced network details if required. The wireless security measures will be determined by the local IT infrastructure, the available options for the Alpha are None (open network), WPA-PSK, WPA-EAP, IEEE8021X
3. Press the green forward button to save.

4. To test the connection, re-select the 'Connect Config' option and press the 'Test Connection' button at the bottom of the screen (see Figure 7).
5. This message confirms if there is a good connection



6. When connected, a WiFi symbol  displays in the status bar, top left.
 - a. Wired Network
7. For a wired connection complete the required information in the 'Wired Network' tab, including:
 - MAC address
 - Connection method (DHCP or Static)
 - IP address
 - Netmask

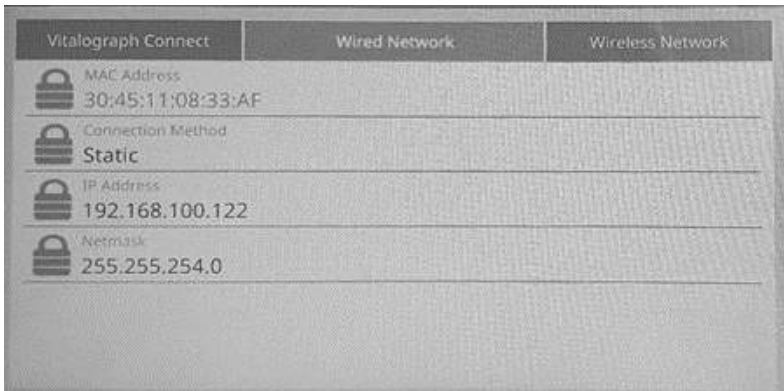

Figure 8 - Example set up for Connect (wired)

8. When connected, a wired Ethernet symbol  displays in the status bar, top left.

Once Connect is configured, the Main menu offers Subject, Quick Test, Configuration and Connect options. (See Section 5, Figures 2.a and 2.b above).

Scroll right to access the Connect option.

The Connect screen has three tabs (see Figure 9).

- New Orders
- Open Orders
- Return Orders

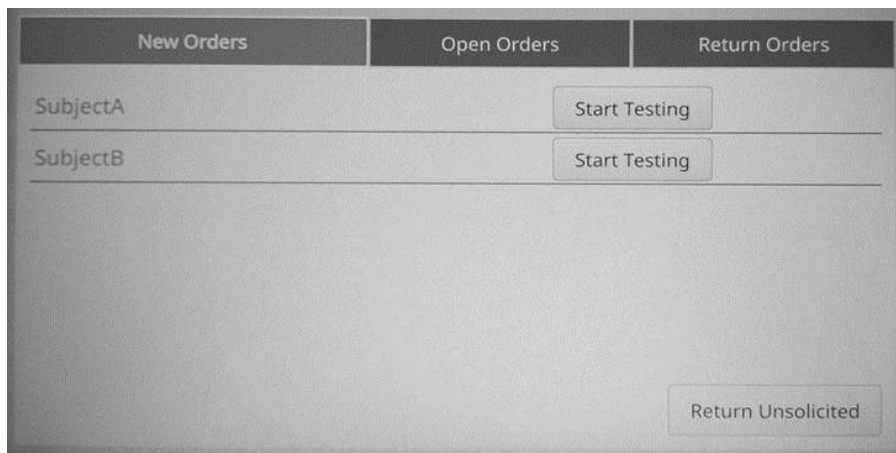

Figure 9

5.5.2. New Orders

To process a new order, go to the 'New Orders' tab, select the order required and press the 'Start Testing' button (see Figure 9). The subject information displays. Review and press the green forward button to proceed with a test. The main test menu displays. Select 'Spirometry' and complete a test (see Section 5.2.1 Testing). When complete, select the green forward button to exit and close the session.

5.5.3. Open Orders

The 'Open Orders' tab shows a list of orders allocated to the device which have not yet had a test completed. These remain on the list until they are processed. To process an open order, select it from the list and follow the same instructions as for new orders in Section 5.5.2 New Orders above.

5.5.4. Return an Order

To return an order to the EMR go to the 'Return Orders' tab, select the order required. All available sessions for that order will be shown.

If the order is complete, ensure the required sessions are selected and press the 'Return' button (see Figure 10). **If additional testing is required** select the 'Start Testing' button first (see Figure 10 below) and press the green forward button to proceed with a test (see section 5.5.2 New Orders). When complete, select the green forward button to return and complete the order.

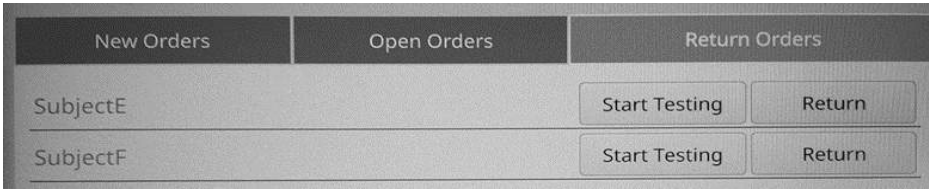

Figure 10

5.5.5. Return Unsolicited

Unsolicited Orders are tests that were not allocated by the EMR. If the EMR is configured for unsolicited orders the user may select the

‘Return Unsolicited’ button , complete a test, and return it to the EMR.

The ‘Return Unsolicited’ button does not show if the EMR is not configured for unsolicited orders.

5.6. Passcode

To enable the passcode, select the ‘Lock’ padlock icon  in the configuration menu. Enter the passcode on the number pad and select the forward button.

The device is now locked, and any user will be prompted for a passcode on start-up.

On the passcode log on screen an  symbol is displayed in the top right corner, which when pressed displays the current date, Model Number and Serial Number.

To disable the passcode, select the ‘Unlock’ padlock icon in the configuration menu and select the forward button.

Note: To reset the passcode contact Vitalograph Technical support, contact information is available at the start of this manual.

5.7. Incentives

Choose the incentive  option and configure target values.

1. Target Values: This represents the VC/FVC to be achieved for the incentive to play out fully i.e., for the ball and tube, this represents volume at which the ball will come out of the tube. The target will use percentage of predicted for the first blow and percentage of the best for all subsequent blows.
2. Start at % VC/FVC: This represents the percentage of the predicted value which must be reached for the incentive to start during the forced manoeuvre.

Note: Ensure device is updated to v1.07 or later to activate incentives, refer to Section 5.3.2.

5.8. Data Transfer with Spirotrac

Subjects can be uploaded from Spirotrac to the device in order to perform testing on the device and download the results from the device to Spirotrac in order to have all the test results in one central location.

5.8.1. Connecting Alpha to a PC

Plug one end of USB cable into USB port on the PC/Laptop running Spirotrac and the other end of the cable into the USB port at side of the Vitalograph Alpha.

Note: Ensure the version of Spirotrac running is 6.7 or later and device is updated to v1.07 or later.

Once switched on and in main screen, the Vitalograph Alpha device is ready for use with Spirotrac.

5.8.2. Uploading subject(s) from Spirotrac to Vitalograph Alpha

Note: Ensure the device is on the main screen.

Note: To ensure subjects are not duplicated, upload the required subject(s) from Spirotrac to the device prior to testing.

1. On Spirotrac select Download/Upload from left hand menu.
2. The “No device connected” icon displays until a successful connection has been established. Once connection is established, the device name and serial number are displayed.
3. Select Upload Subjects.
4. To find the subject you wish to transfer to the device, there is a quick search option and an advanced option. Once found, move the subject to right hand list.
 - a. Use the quick search option by entering the subject number or name in the search field provided.
 - b. Use the advanced option to find subjects by any/all of the following: Group, Subject Id, First Name, Last Name, Alternate Id, Date of Birth.
5. On selecting Upload subjects to device, the subject(s) are saved to the device.
6. When a subject already exists on the device with the same subject number but was not linked previously the user will be asked to choose from one of the following options during the upload process:
 - a. Update existing subject – this will update the device subject with current demographics from Spirotrac.
 - b. Create new Subject – this will add a new subject to the device.
 - c. Skip – no subject demographics is transferred to the device.

5.8.3. Downloading subject(s) from Vitalograph Alpha to Spirotrac

Note: Ensure the device is on the main screen.

1. On Spirotrac select Download/Upload from left hand menu.
2. The “No device connected” icon displays until a successful connection has been established. Once connection is established, the device name and serial number are displayed.
3. Select Download Sessions.
4. To find the sessions required for download to Spirotrac, there are 2 quick search options and a custom search option.
 - a. Use the quick search option(s) to find sessions performed on the device today or find all sessions.
 - b. Use the custom search option to find sessions by Date Range, Type or Subject information (First Name, Last Name, Subject Number)
5. All subject(s)/session(s) matching the search criteria are displayed on screen.
6. Select session(s) to be downloaded.
7. On selecting Download Selected the session(s) are saved to Spirotrac.

Note: Subject information is downloaded also. All downloaded session(s) are now available to view in the subjects visit list and available for trending.

8. When a subject already exists on Spirotrac, but demographics differ the user will be asked to choose from one of the following options during the download process:
 - a. Update existing subject – this will update the Spirotrac subject with current demographics from device.
 - b. Create new Subject – this will add a new subject to Spirotrac.
 - c. Skip – no data/session(s) are downloaded for this subject.
9. Once download is complete, Spirotrac displays the list of session(s) which have been downloaded and the user can select session(s) to be printed or exported to PDF.

6. Cybersecurity Considerations

6.1. Specification

The device employs an Operating System (OS) that is not accessible under normal use. The application runs on top of the OS and is the only user interface to the device. The OS has a configured firewall to protect against any unauthorised access over the communications ports, only Vitalograph PC based applications can access the device over a secure connection. No further controls are required to be applied by users to secure the device. The device will timeout and auto power down after 5 minutes of inactivity.

6.2. Security Recommendations

When connecting to a PC it is recommended that the PC has the following cybersecurity in place:

- **Up to date Operating System:** the Operating System should be configured for automatic update for security patches and have all of the latest patches applied.
- **Antivirus/antimalware:** the PC should have a reputable antivirus or antimalware application installed and all updated virus definitions in place.
- **Secure Login:** the PC should be password protected via industry standard user access controls, via active directory or other methods.
- **Firewall:** if the PC is connected to the internet ensure a reputable firewall or equivalent protection is in place to protect against unauthorised external access.

6.3. Interfaces

Communications interfaces – USB, WiFi, Ethernet: The device will communicate with Vitalograph PC based applications for:

- Back-ups and restore
- Software updates
- Printing to external printer
- Transfer of test data

SD Card: Only used for encrypted backup of stored data.

7. Power Management

The device can be powered using the 12V low voltage Power Supply with which it is supplied, or from the internal Battery Pack.

7.1. Battery Pack

The device is fitted with a rechargeable Battery Pack which allows it to be used without the 12V power supply connected. To fully recharge, switch off the device and leave the power supply plugged in overnight. A full charge will allow 5 hours testing with 5 reports from the internal printer.



Note: *With the power supply plugged in the device will continue to charge even if it auto powers down after 5 minutes of inactivity.*

The recommended battery pack replacement interval is 3 years. Battery replacement should be carried out only by the manufacturer, the approved importer or by Service Agents approved by Vitalograph.

Note: *Powering the device or recharging the battery pack from the USB is not possible.*

7.2. Battery Power Indications

The device has several battery power indications:

	<p>When the battery is fully charged, a white 'Battery Full' icon displays on the status bar at the top of the screen. Disconnect the device from external power source when it is fully charged.</p>
	<p>When the battery is at less than 20% capacity, an orange 'Battery Low' icon displays on the status bar at the top of the screen. You may continue to use the device, but it is advisable to connect to an external power source.</p>
	<p>When the battery is approaching fully discharged the red 'Battery Discharged' icon displays on the status bar at the top of the screen. If the battery is at less than 5% capacity the device powers down. Connect to an external power source to recharge the battery before attempting to use the device again.</p>

7.3. Power Save Mode

The device will auto power down after 5 minutes whether the power is plugged in or not. Pressing the On/Off button will turn the device back on.

8. Cleaning & Hygiene

8.1. Preventing Cross-Contamination of Subjects

A spirometer is not designed or supplied as a 'sterile' device. Vitalograph intends that a new Bacterial Viral Filter (BVF) be used for every subject to prevent cross contamination. Using a new BVF provides a significant level of protection of the subject, the device and the user against cross contamination during spirometry manoeuvres. The interior of a Vitalograph flowhead does not require decontamination where a new BVF is used for each subject. The outside surfaces of the device and flowhead tube may be cleaned with a 70% isopropyl alcohol impregnated cloth to remove any visible soiling and for low level disinfection. There are no special temperature requirements for cleaning, which may be carried out at room temperature. After cleaning, the device should be inspected for residual soiling and repeat cleaning carried out if required.

Table of Cleaning/Disinfection Methods

Part	Clean/ Low Level Disinfection	Recommended Cleaning/Low Level Disinfection
Case exterior	Clean	Wiping with a 70% isopropyl alcohol impregnated cloth provides a suitable form of cleaning. The exposure time for low level disinfection using 70% IPA wipes is ≥ 1 minute. ²
Screen	Clean	For the screen, lightly wipe the surface with cotton pad or other soft material. Note: DO NOT use any chemicals. DO NOT wipe in a circular motion. Strokes should be either up/down or over/back.

Where the user suspects that the flowhead has become contaminated or where local risk assessment identifies a need for higher level of decontamination, then it should be cleaned as per the instructions on 'Cleaning and Hygiene' on the Vitalograph website.

8.2. Inspection of the Vitalograph Model 6000 Alpha

No inspection of the device is required by the subject. The device is used under the supervision of a healthcare professional.

For the healthcare professional a visual inspection is recommended on a routine basis. Examine cone and flow conditioning mesh filter for damage or contamination. If it is damaged or blocked, it should be replaced with a new part. Examine the Fleisch element and replace if damaged.

If you suspect the flowhead has become contaminated or where user risk assessment identifies a need for higher level of decontamination, then it should be cleaned as per the instructions on 'Cleaning and Hygiene' on the Vitalograph website.

² Rutala, W. A. 2017 "Back to the Basics" accessed from disinfection&sterilization.org, June 2020

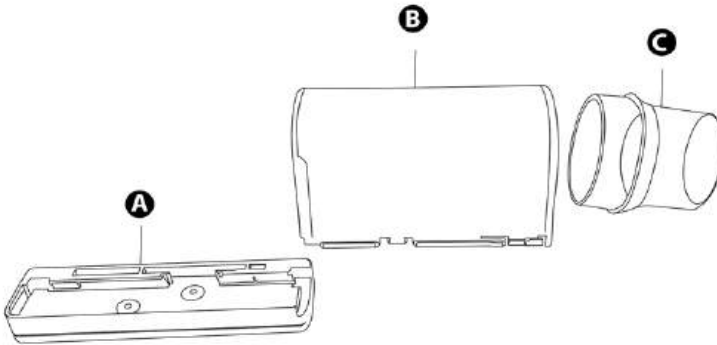

Figure 10: Flowhead Assembly

A	Flowhead Base
B	Flowhead containing Fleisch
C	Flowhead Cone

It is recommended that a calibration verification is carried out following cleaning and re-assembly as recommended in the ATS/ERS 2019 guidelines³.

³ Derived from terminology and guidance taken from ATS/ERS Standardisation of Spirometry 2019 Update Am J Respir Crit Care Med 2019 Vol 200, Iss 8 pp e70-e88

9. Fault Finding Guide

Problem Fault Symptoms:	<ul style="list-style-type: none"> • Calibration verification variations > +/-3% • False readings suspected
Possible Cause/ Solution: (In probable order)	<ul style="list-style-type: none"> • The % error indicates the severity of the issue. Over 3%, repeat calibration verification. Over 6% may indicate the device requires cleaning or maintenance. Over 25%, the user should contact technical support. • Was the correct syringe volume selected? • Flowhead pressure tapping holes blocked. • Flowhead Fleisch element assembly sealing 'O' rings damaged. • Flowhead Fleisch element assembly blocked. • Cold syringe. Ensure syringe is in its test environment for at least an hour before use. • Internal tubing from pressure ports on device is blocked. Contact support. • EMI (Electromagnetic Interference) that exceeds EN60601-1-2 EMC standard. Turn off offending device or move the Alpha to another location and repeat. • Electronics failure. Contact support.
Problem Fault Symptoms:	<ul style="list-style-type: none"> • Printout is blank • Cannot print to internal printer
Possible Cause/ Solution: (In probable order)	<ul style="list-style-type: none"> • Check paper is loaded correctly and not reversed. • Internal printer failure. Contact support.
Problem Fault Symptoms:	<ul style="list-style-type: none"> • Tests begin automatically • Volume accumulates automatically without the subject blowing • Very small VC or FVC test displayed
Possible Cause/ Solution: (In probable order)	<ul style="list-style-type: none"> • Flowhead and/or tubing not stationary at the start of test. Hold them steady until the 'Ready to Blow' prompt appears. • Return to previous menu and re-enter the test.
Problem Fault Symptoms:	<ul style="list-style-type: none"> • Rocking device
Possible Cause/ Solution: (In probable order)	<ul style="list-style-type: none"> • Ensure device is on a flat surface. • Check for damaged or missing feet. • If any of the feet are damaged or missing replace both feet.

Problem Fault Symptoms:	<ul style="list-style-type: none"> • Cannot read screen.
Possible Cause/ Solution: (In probable order)	<ul style="list-style-type: none"> • Ensure the on/off button was pressed. • If running off battery, ensure the device is charged and/or the power supply is connected. • Electronics failure. Contact support.
Problem Fault Symptoms:	<ul style="list-style-type: none"> • Reversed or no volume measurements.
Possible Cause/ Solution: (In probable order)	<ul style="list-style-type: none"> • Ensure tubing is connected correctly. • Ensure flowhead connecting tube is not pinched or trapped.
Problem Fault Symptoms:	<ul style="list-style-type: none"> • Cannot connect to EMR over WiFi.
Possible Cause/ Solution: (In probable order)	<ul style="list-style-type: none"> • Check that WiFi symbol is showing on status bar and if it is not, repeat steps in 5.5.1. • Ensure correct WiFi network is selected and pass key is correct. • Check the connection by pressing the 'Test Connection' button in the 'Connect Config' screen. • Contact support.
Problem Fault Symptoms:	<ul style="list-style-type: none"> • Screen is frozen
Possible Solution: (In probable order)	<ul style="list-style-type: none"> • Requires hard reset – press and hold the power button for 10+ seconds, until it powers down and back on again.

9.1. Software Check

Information about the device can be obtained from the About box. This information can be used if any queries are made to Vitalograph or a service agent.



To access the About box , select 'Configuration' on the Main Menu and go to the second screen of options.

9.2. Product Useful Life Checks

To ascertain whether the device has exceeded its useful life Vitalograph recommends checking the flowhead and the batteries.

The flowhead may be checked with the daily calibration verification, to

be completed by the clinician/healthcare professional, and during the periodic inspection of the device. Reference section 5.4 Calibration Verification for details on how to check the device flowhead.

As the main battery pack ages, the required charging frequency will increase, and the battery life will decrease. Vitalograph recommend changing the battery pack every 3 years or when the product useful life checks indicate it is required.

The clock may reset to a default time and date on power down if the 3V coin cell battery has depleted. Vitalograph recommend changing the battery during routine service.

10. Customer Service

Service and repairs should be carried out only by the manufacturer, or by Service Agents approved by Vitalograph.

For the names and addresses of approved Vitalograph Service Agents, please refer to the contact information at the start of this manual.

Any serious incident that has occurred in relation to the device should be reported to Vitalograph or its Authorised Representative and the Regulatory Authorities of the country. Refer to the Vitalograph contact information at the start of this manual.

11. Consumables and Accessories

Cat. No	Description
28350	BVF (50)
20303	Nose clip (200)
36020	3L precision syringe
42175	Double wall tubing 1M length
67252	USB A to USB B cable
42175	Flowhead Connection Tube
65054	Alpha 12V PSU (SL Power MPN: ME20A1200805 part)
65055	Alpha 12V PSU Spare EU, AU, US (SL Power MPN: ME20A1200805 part)
69128	6000 Alpha feet set
41601	micro SD Class 10
69129	6000 Alpha main PCBA

69130	Flowhead
69131	Flowhead cone (5)
69132	6000 Alpha service kit
69133	6000 Alpha LCD
69134	6000 Alpha printer
69135	6000 Alpha carry case
69136	6000 Alpha printer door
69137	6000 Alpha battery pack
69138	6000 Alpha switch PCBA
69139	6000 Alpha shoulder strap bag
41602	Ethernet cable 1M
69125SPR	Alpha printer paper roll packed (previously 69140)









12. Disposal

The device must be taken to separate collection at the product end-of-life. Do not dispose of these products as unsorted municipal waste. Used BVFs constitute minimally soiled waste from human healthcare. BVFs are made from recyclable material and should be disposed of in line with local requirements.



13. Explanation of Symbols

Symbol	Description
	Type B equipment
	Class II
VA	Power rating
v	Direct current
	Instructions for Use; operating instructions
	Manufacturer
	Date of Manufacture (include date in format yyyy-mm-dd)
	USB connection

	Ethernet connection
	The device must be taken to separate collection at the product end-of-life. Do not dispose of these products as unsorted municipal waste
	Fragile, handle with care
	Keep Dry
	Do not re-use
	Nonsterile
	Recycle
	QR code - matrix bar code. All information in the bar code is included in the text under it
Rx Only	Restricted to sale by, or on the order of a physician
	MR Unsafe – Do not use this device in an MRI environment.

14. Description of the Vitalograph Model 6000 Alpha

The Vitalograph Model 6000 Alpha is a spirometer designed for lung function testing in a variety of professional healthcare environments, e.g., primary care, hospitals and occupational health centres. The device is designed for desktop use. The Fleisch flowhead is used for testing and has a resting location on the device.

Spirometry is a valuable tool that provides important information to clinicians which is used together with other physical findings, symptoms, and history to reach a diagnosis (ATS/ERS 2019). And as such, spirometry may support or exclude diagnosis, but it cannot make one.

Spirometers are also used in non-clinical settings such as occupational health screening where no clinical judgment is made, suspect findings leading to a referral to a clinician. The device is intended for use by medical professionals trained in respiratory and lung function testing. Apart from this instruction manual, there are no other training requirements for the medical professional.

15. Technical Specification

Product	Vitalograph Model 6000 Alpha
Model	6000
Flow Detection Principal	Fleisch type pneumotachograph
Essential Performance	Flow measurement output
Essential Performance Test Limits	Flow Accuracy $\pm 10\%$ or ± 20 L/min, whichever is greater
Back pressure	Less than 0.15kPa/L/second @ 14 L/s
Volume detection	Flow integration sampling @ 100Hz
Maximum test duration	90 seconds
Volume accuracy	$\pm 2.5\%$ ATS/ERS 2019, ISO 26782
Voltage/frequency	Power supply: Input 100-240V, 50/60Hz, 0.5A Output 12V, 1.5A Battery: 7.2V, 2.2Ahr
Accuracy when operated in operating temperature range conditions	Flow $\pm 10\%$ Max. flow rate ± 16 L/s Min. flow rate ± 0.02 L/s
Operating temperature range	ISO 26782 limits: 17 – 37°C Design limits: 10 – 40°C
Operating humidity range	30% – 75%
Ambient pressure range	850hPa – 1060hPa
Performance standards	ATS/ERS 2019, ISO 23747:2015 & ISO 26782:2009
Safety standards	EN 60601-1:2006 + A1:2013 + A2:2021
EMC Standards	EN 60601-1-2:2015 + A1:2021
Coexistence standards	ANSI C63.27-2017 American National Standard for Evaluation of Wireless Coexistence.
QA/GMP standards	EN ISO 13485, FDA 21 CFR 820, CMDR SOR/98-282, Japan's PMD Act & MDSAP
Dimensions	204mm (length) x 253mm (width)

Weight	1.5kg
Communications	USB, Ethernet, WiFi
Wireless technology	<p>WiFi 802.11bgn</p> <p>Module: WL1831MOD Wi-Fi Texas Instruments Certified/ approved FCC, IC, ETSI/CE, Japan MIC.</p> <p>FCC ID: Z64-WL18SBMOD</p> <p>IC: 4511-WL18SBMOD</p> <p>MIC (Japan): 201-135370</p> <p>Frequency 2.4-GHz (2412 – 2484 MHz).</p> <p>Maximum RMS output power measured at 1dB: 17.3dBm</p>
Power Supply	<p>12V, 1.5A DC power supply</p> <p>7.2V, 2.2Ahr NiMh battery</p>
Service life	The recommended service life of the device is 3 years or when product useful life checks indicate it is required.
Product life	<p>10years+ when maintenance and servicing (every 3 years) procedures are adhered to.</p> <p>Reference section 9.2 'Product useful life checks' for information on how to ascertain whether the device has exceeded its useful life.</p>
Minimum PC System Requirements	<p>Processor Speed: 2GHz or greater</p> <p>RAM: 2GB (Min), 4GB (Recommended)</p> <p>Disk Space: 1GB or greater</p> <p>Operating System: Windows 7 or above</p> <p>Monitor: 1280 x 800 pixel or above.</p> <p>Other:</p> <ul style="list-style-type: none"> • .Net framework 4.5.1 • USB Port

Notes:

- All values displayed are expressed as BTPS values.
- Take care not to block the cone with the tongue or teeth. A 'spitting' action or coughing will give false readings.
- Time zero is determined using the back-extrapolated method, from the steepest part of the curve. The operating conditions specified apply to the device plus accessories.
- The flowhead and BVF are classified as type B applied parts. The device body or other accessories are not applied parts.
An applied part is a part of the equipment, that in normal use necessarily comes into physical contact with the subject for equipment or system to perform its function

16. CE Notice



Marking by the symbol  indicates compliance of the Vitalograph Model 6000 Alpha to the Medical Devices Directive of the European Community.

The device is intended for and suitable for use in a variety of professional healthcare environments, e.g. primary care, hospital wards, occupational health centres and clinics, except for near active high frequency surgical equipment and the RF shielded room of an ME system for magnetic resonance imaging, where the intensity of electromagnetic disturbance is high. The customer or the user of the device should assure that it is used in such an environment.

The device was tested in accordance with:

EN 60601-1:2006 + A1:2013 + A2:2021 with US deviations - Medical electrical equipment – Part 1: General requirements for basic safety and essential performance

EN 60601-1-2: 2015 + A1:2021 - Medical electrical equipment - Part 1-2: General requirements for basic safety and essential performance - Collateral Standard: Electromagnetic disturbances - Requirements and tests.

Coexistence: ANSI C63.27-2017 American National Standard for Evaluation of Wireless Coexistence

EN 60601-1-2:2015 + A1:2021 - Emissions tests

During the immunity testing below the device continued to operate within specification

Emissions test	Compliance	Electromagnetic environment - guidance
RF emissions CISPR 11	Group 1	The device uses RF energy only for its internal function. Therefore, its RF emissions are very low and are not likely to cause any interference in nearby electronic equipment.
RF emissions CISPR 11 IEC 61000-3-2 Harmonic Emissions IEC 61000-3-3 Voltage fluctuations/flicker emissions	Class B Class A Class A	The device is suitable for use in all establishments, including those connected to the public mains network (e.g. doctor's offices in residential areas)

EN 60601-1-2:2015 + A1:2021 - Immunity tests

Immunity test	Test level	Compliance level Reached
Electrostatic discharge (ESD) EN 61000-4-2	Contact: ± 8 kV Air: ± 2 kV, ± 4 kV, ± 8 kV, ± 15 kV	Contact: ± 8 kV Air: ± 2 kV, ± 4 kV, ± 8 kV, ± 15 kV
Electrical fast transient/burst EN 61000-4-4	± 2 kV for power supply lines	+/- 2kV
Surge EN 61000-4-5	± 0.5 kV, ± 1 kV differential mode Device is identified as Class II unearthed equipment therefore common mode testing is omitted.	+/- 0.5 kV, 1kV
Voltage dips, short interruptions on power supply input lines EN 61000-4-11	100% drop, 0.5 cycles, 0°, 45°, 90°, 135°, 180°, 225°, 270°, 315° 100% dip, 1 cycle 30% dips, 25/30 cycles 240V AC, 50Hz 100V AC, 50Hz	100% drop, 0.5 cycles, 0°, 45°, 90°, 135°, 180°, 225°, 270°, 315° 100% dip, 1 cycle 30% dip, 25/30 cycles 240V AC, 50Hz 100V AC, 50Hz

Conducted RF EN 61000-4-6	3V/m 0.15-80MHz 6V/m ISM/amateur radios bands 0.15-80MHz 80% AM at 1kHz	3V/m 0.15-80MHz 6V/m ISM/amateur radios bands 0.15-80MHz 80% AM at 1kHz
Radiated RF EN 61000-4-3	3V/m (professional healthcare) 80MHz to 2700MHz	3V/m (professional healthcare) 80MHz to 2700MHz
Proximity fields from RF devices EN 61000-4-3	9 to 28V/m 385 to 5785MHz As per Table 9 EN60601-1-2:2015	9 to 28V/m 385 to 5785MHz As per Table 9 EN60601-1-2:2015
Power frequency (120V, 60Hz and 240V, 50Hz) magnetic field	30A/m	30A/m
Proximity magnetic Fields EN 61000-4-39	8A/m 30kHz 65A/m 134.2kHz (2.1 kHz PM) 7.5A/m 13.56MHz (50 kHz PM)	8A/m 30kHz 65A/m 134.2 kHz (2.1 kHz PM) 7.5A/m 13.56 MHz (50 kHz PM)

Medical Devices may be affected by mobile RF communications equipment including cellular telephones and other personal or household devices not intended for medical facilities. It is recommended that all equipment used near the Vitalograph product comply with the medical electromagnetic compatibility standard and to check before use that no interference is evident or possible. Loss or degraded performance due to EMI that exceeds the test levels in immunity test tables above will result in a failed calibration verification. Reference section 5.4 of this document for details on completing a calibration verification on the Alpha.

If interference is suspected or possible, move the Alpha to a new location and repeat the calibration verification.

Medical electrical equipment needs special precautions regarding EMC and needs to be installed and put into service according to the EMC information provided.

The Model 6000 Alpha is a Spirometer and so the performance deemed to be essential is the output of the flow transducer

WARNING: No modification of this equipment is allowed.

17. FDA Notice

Caution: Federal Law restricts this device to sale by, or on the order of a physician.

18. EU Declaration of Conformity

Product: Vitalograph Model 6000 Alpha

Vitalograph hereby ensures and declares that the above product associated with these instructions for use, is designed and manufactured in accordance with the following QMS regulations and standards:

European Medical Devices Directive {MDD} 93/42/EEC, as amended.

This device is classified as IIa per Annex IX of the MDD also meets the provisions of the Essential Requirements, Annex I, via compliance with Annex II of the Medical Devices Directive as per Article 11, section 3a, excluding point 4 of Annex II.

- Canadian Medical Device Regulation {CMDR SOR/98-282}
- FDA Quality System Regulation {QSR} 21 CFR 820.
- EN ISO 13485 Medical devices. Quality management systems. Requirements for regulatory purposes.



Certifying Body: British Standards Institute {BSI}.

BSI Notified Body #: 2797

Certificate Nos. CE 00772, MD 82182

Signed on behalf of Vitalograph (Ireland) Ltd.

A handwritten signature in black ink that reads 'Frank Keane'.

Frank Keane.

CEO, Vitalograph Ltd.

19. Guarantee & Free Five Year Warranty

Subject to the conditions listed below, Vitalograph Ltd. and its associated companies, (hereinafter called the Company) guarantee to repair or at its option replace any component thereof, which, in the opinion of the Company is faulty or below standard as a result of inferior workmanship or materials.

The conditions of this Guarantee are:

1. This Guarantee shall only apply to hardware defects which are notified to the Company or to its accredited distributor within two years of the date of purchase of the equipment, unless otherwise agreed in writing by the Company. Registration is not required for this base two year guarantee.
2. An extended five year warranty from date of purchase, is available by registering the products serial number at www.vitalograph.com/warranty within 30 days of purchase.
3. Software (meaning computer software, or user installable modules) is guaranteed for 90 days from the date of purchase.
4. The Company warrants that the software when correctly used in conjunction with the hardware will perform in the manner described in the Company's literature and user manuals. The Company undertakes to rectify at no expense to the customer any software failure notified within the period stated above, provided that the failure can be recreated and the software has been installed and used in accordance with the user manual. Notwithstanding this clause, the software is not warranted to be free of errors.
5. This Guarantee does not cover any faults caused by accident, misuse, neglect, tampering with the equipment, use of consumable items or parts not approved by the Company, or any attempt at adjustment or repair other than by personnel accredited by the Company, nor does it cover reinstatement of any configuration changes caused by the installation of any software.
6. If a defect occurs please contact the supplier from it was purchased for advice. The Company does not authorize any person to create for it any other obligation or liability in connection with Vitalograph® equipment.
7. This Guarantee is not transferable and no person, firm or company has any authority to vary the terms or conditions of this guarantee.
8. To the maximum extent permitted by law, the Company does not accept liability for any consequential damages arising out of the use of, or inability to use any Vitalograph® equipment.
9. This Guarantee is offered as an additional benefit to the Consumer's statutory rights and does not affect these rights in any way.

